

ITEM **#720302, #720304**
THREE TIERED COUNTER BOWL WITH METAL BASE

C

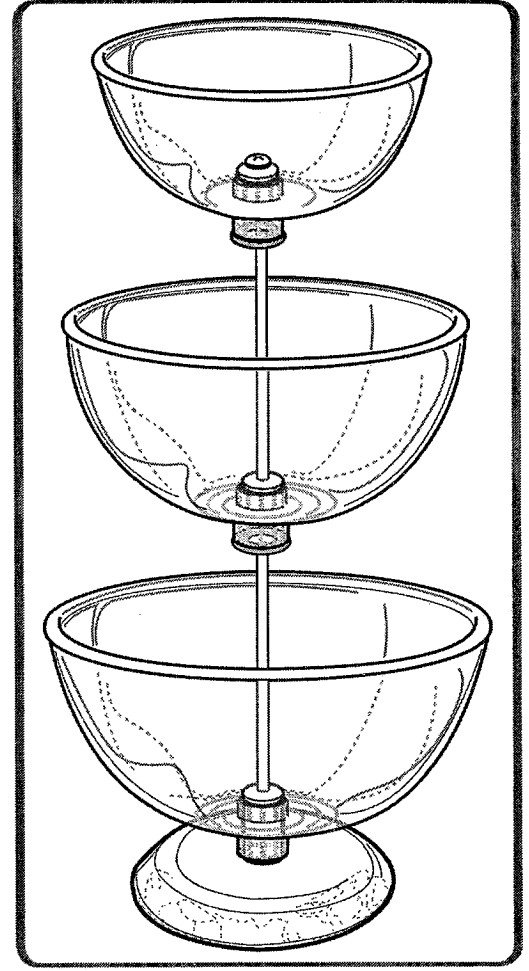

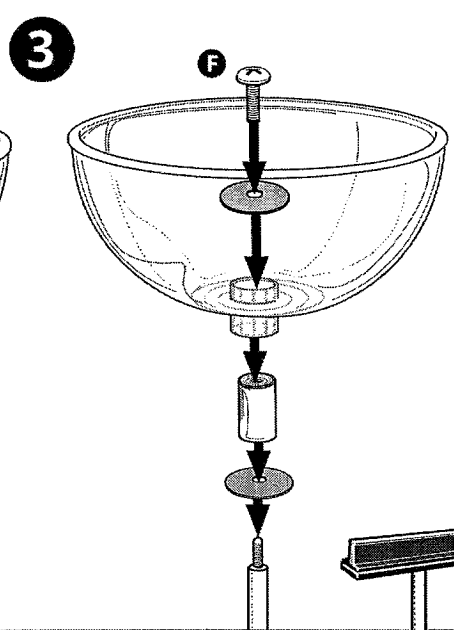

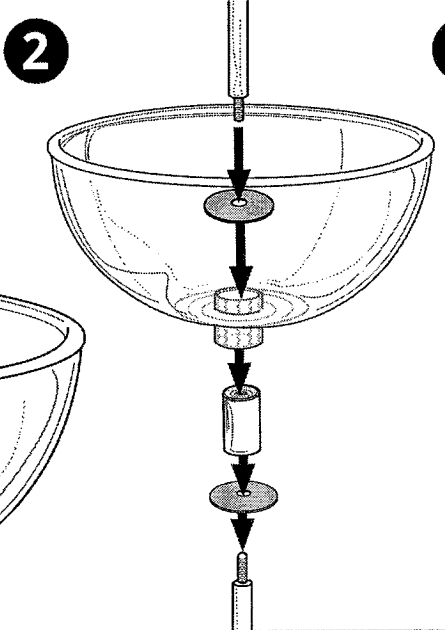
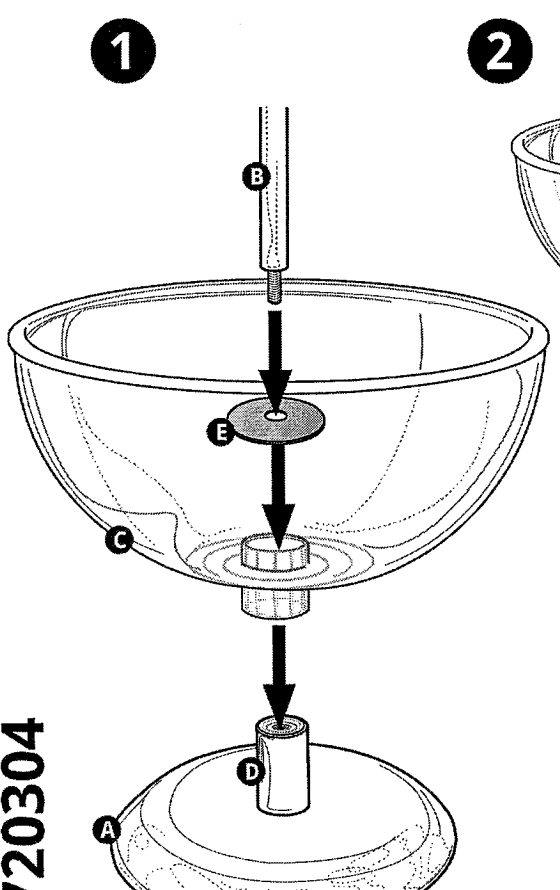

ADD A SIGN OPTION

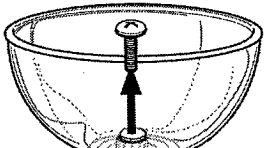
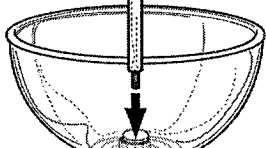
Remove the top screw as shown on **figure A**.

Screw in the sign holder as shown in **figure B**.

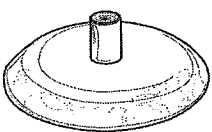
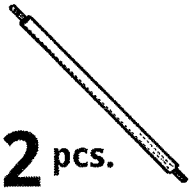
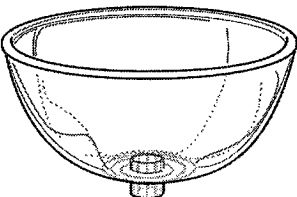
#720302, #720304

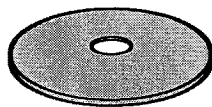
<p>A PART# 300809</p>  <p>1 pc. 8" DIA. METAL BASE</p>	<p>B PART# P-POLE-7</p>  <p>2 pcs. 7" L METAL ROD W/ THREAD</p>	<p>C #720302 PART# 700907 - 8" BOWL PART# 700905 - 10" BOWL PART# 700922 - 12" BOWL</p> <p>#720304 PART# 700905 - 10" BOWL PART# 700922 - 12" BOWL PART# 700906 - 14" BOWL</p>  <p>3 pcs. PLASTIC BOWLS</p>	<p>D PART# P-TUBE-1.75 600025 XZ</p>  <p>3 pcs. 1.75" METAL POLE</p>	<p>E PART# WASHER-1.5PL</p>  <p>5 pcs. 1.5 PLASTIC WASHER</p>	<p>F PART# P-SCREW-25-.62</p>  <p>1 pc. 1/4" SCREW</p>
---	--	---	---	--	---