

WAVE15-S-APS

16.9" x 17.2" x 9.7"
(42.9cm x 43.7cm x 24.6cm)



- BrewMETER® and pulse brew routines to adjust flavor profile
- Adjustable legs to accommodate up to 3.0L lever action and 2.5L push button BUNN airpots and thermal servers
- Brew into 1.9L thermal carafe using the slide-out booster tray
- Choice of three pulse brew routines to adjust your flavor profile
- Red/green LED provide brewer status (ready, heating, brewing)
- SmartWAVE technology increases turbulence in the brew funnel
- Energy-saver mode reduces tank temperature during idle periods
- Ensures coffee brew quality with cold brew lock out capability
- SplashGard® funnel deflects hot liquids away from the hand

Servers and airpots sold separately

Agency:



Specifications

Product #: 39900.0006

Water Access: Plumbed

Finish: Stainless

Funnel: Black Plastic

Faucet: Lower

Additional Features

Silver Series

BrewMETER

Electrical & Capacity

Volts	Amps	Watts	Cord Attached	Plug Type	8oz cups/hr 236ml cups/hr	Input H ₂ O Temp.	Phase	# Wires plus Ground	Hertz
120	11.3	1350	Yes	NEMA 5-15P	62	60°F (15.5°C)	1	2	60

Plumbing Requirements

PSI	kPa	Fitting Supplied	Water Flow Required (GPM)
20-90	138-621	1/4" Male Flare Fitting	-

CAD Drawings

2D	Revit	KLC
•		



BUNN® reserves the right to change specifications and product design without notice. Such revisions do not entitle the buyer to corresponding changes, improvements, additions or replacements for previously purchased equipment. For most current specifications and other info visit bunn.com.

Created on:
01/20/2016

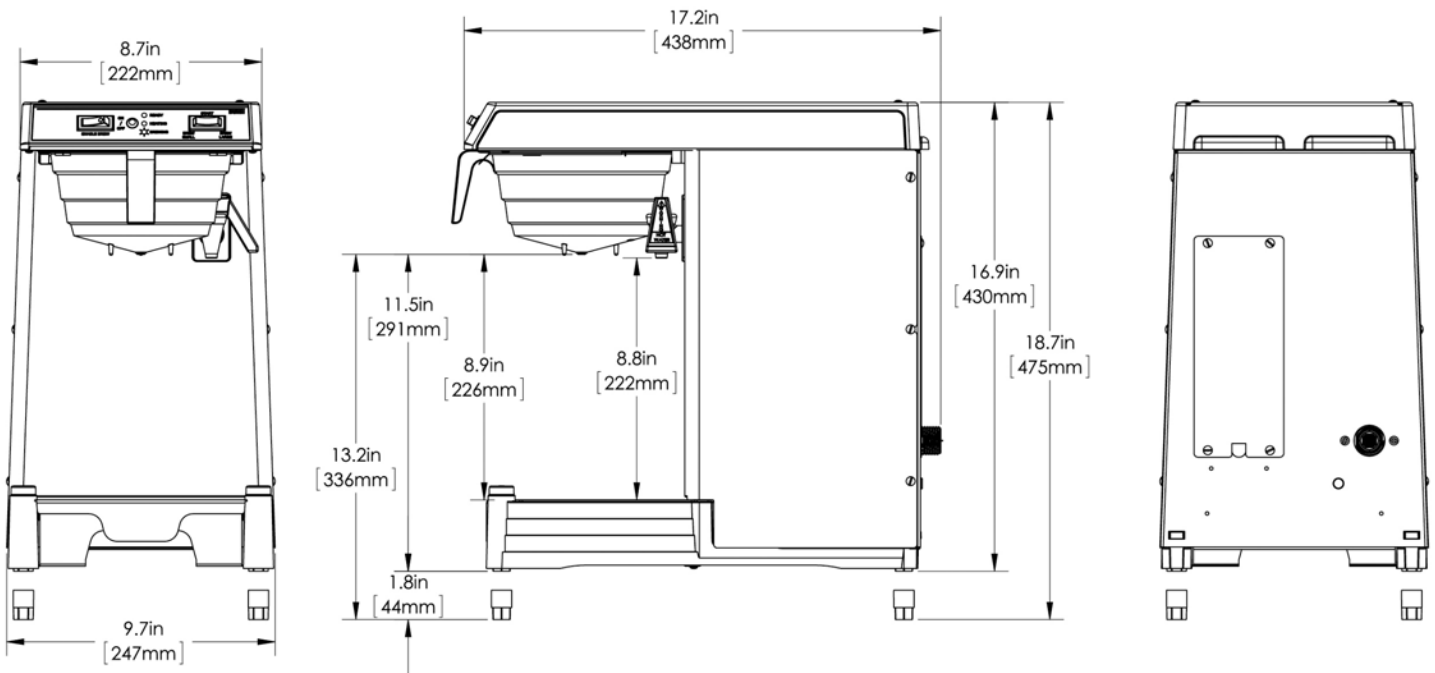
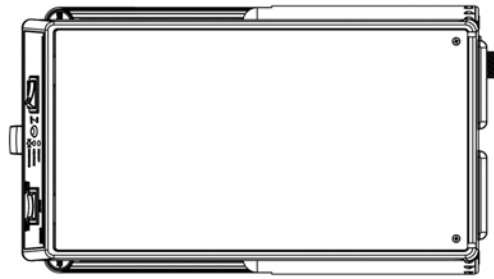

	Unit			Shipping				
	Width	Height	Depth	Width	Height	Depth	Weight	Volume
English	9.7 in.	16.9 in.	17.2 in.	-	-	-	24.257 lbs	2.505 ft ³
Metric	24.6 cm	42.9 cm	43.7 cm	-	-	-	11.003 kgs	0.071 m ³



BUNN® reserves the right to change specifications and product design without notice. Such revisions do not entitle the buyer to corresponding changes, improvements, additions or replacements for previously purchased equipment. For most current specifications and other info visit bunn.com.

Created on:
01/20/2016

Related Products & Accessories:WAVE15-S-APS(39900.0006)



FILTERS,REGULAR1M
500/2 50/CL

Product #: 20115.0000



FUNNEL W/DECALS,
BLACK PLASTIC

Product #: 20583.0003



WATER FILTER
SYSTEM, EQ-17-TL

Product #: 30200.1000



WATER FILTER,IN LINE
ED-17-TL

















Product #: 30201.1001



BUNN® reserves the right to change specifications and product design without notice. Such revisions do not entitle the buyer to corresponding changes, improvements, additions or replacements for previously purchased equipment. For most current specifications and other info visit bunn.com.

Created on:
01/20/2016

Serving & Holding Options: WAVE15-S-APS(39900.0006)

 <p>AIRPOT, 2.5L GL PB SINGLE PK</p> <p>Product #:13041.0001</p>	 <p>AIRPOT, 2.5L GL PB 6/ CASE</p> <p>Product #:13041.0101</p>	 <p>TSR-1,THERMAL SRVR RACK-1 POSN</p> <p>Product #:18008.6001</p>	 <p>AIRPOT, 2.2L GL PB SINGLE PK</p> <p>Product #:28696.0002</p>	<p>NO IMAGE AVAILABLE</p> <p>AIRPOT, 2.2L GL PB 6/ CASE</p> <p>Product #:28696.0006</p>
 <p>AIRPOT, 2.5L SST LA SINGLE PK</p> <p>Product #:32125.0000</p>	 <p>AIRPOT, 2.5L SST LA 6/ CASE</p> <p>Product #:32125.0100</p>	 <p>AIRPOT, 3.0L SST LA SINGLE PK</p> <p>Product #:32130.0000</p>	 <p>AIRPOT, 3.0L SST LA 6/ CASE</p> <p>Product #:32130.0100</p>	 <p>THERMAL CARAFE, BLK 1.9L 1PK</p> <p>Product #:36029.0001</p>
 <p>THERMAL CARAFE,ORN 1.9L 12PK</p> <p>Product #:36252.0000</p>	 <p>THERMAL CARAFE,ORN 1.9L 1PK</p> <p>Product #:36252.0001</p>	 <p>PITCHER,SST 1.9L TALL- SNGL PK</p> <p>Product #:39430.0000</p>	 <p>PITCHER,SST 1.9L TALL-6/CASE</p> <p>Product #:39430.0100</p>	 <p>CARAFE,SST 1.9L SHRT BLK 1/</p> <p>Product #:40163.0000</p>
 <p>CARAFE,SST 1.9L SHRT ORN 1/</p> <p>Product #:40163.0001</p>	 <p>CARAFE,SST 1.9L SHRT BLK 12/</p> <p>Product #:40163.0100</p>	 <p>CARAFE,SST 1.9L SHRT ORN 12/</p> <p>Product #:40163.0101</p>	<p>NO IMAGE AVAILABLE</p> <p>THERMAL SRVR, 2.5L 6/ CS NO BASE GL LINR</p> <p>Product #:45882.0001</p>	<p>NO IMAGE AVAILABLE</p> <p>THERMAL SRVR, 2.5L NO BASE GL LINER</p> <p>Product #:45882.0003</p>



BUNN® reserves the right to change specifications and product design without notice. Such revisions do not entitle the buyer to corresponding changes, improvements, additions or replacements for previously purchased equipment. For most current specifications and other info visit bunn.com.

Created on:
01/20/2016