



Since 1911

# Countertop Refrigerators

## Instruction Manual



**CTR2.86LD**  
with Lighted Display



**CTR3.75**



### Models:

- CTR2.68LD - Countertop Refrigerator**
- CTR3.75 - Countertop Refrigerator**

### Table of Contents

Model specifications .....	pg. 2
Setting and temperature adjustments .....	pg. 2
Safety precautions .....	pg. 3-5
How to use .....	pg. 6
Cleaning instructions .....	pg. 7
What to do if the following occurs .....	pg. 8
Portability & storage, maintenance, caution ...	pg. 9
Before requesting service .....	pg. 10
Graphic templates for CTR2.68LD .....	pg. 11
Data Label / Wiring Diagram .....	pg. 11
Spare parts list .....	pg. 12

**Cecilware Corporation** 43-05 20th. Avenue, LIC NY 11105  
Tel: 800.935.2211 / 718.932.1414 • Fax: 718.932.7860



Since 1911

[www.cecilware.com](http://www.cecilware.com)

Model Number	CTR2.68LD	CTR3.75
Dimensions (WxDxH)	18"x18 <sup>3</sup> / <sub>8</sub> " x 36 <sup>1</sup> / <sub>2</sub> "	18 <sup>3</sup> / <sub>4</sub> "x18"x 33 <sup>1</sup> / <sub>4</sub> "
Inner Cabinet Dimensions	14 <sup>7</sup> / <sub>16</sub> "x 12 <sup>5</sup> / <sub>8</sub> "x 25 <sup>3</sup> / <sub>8</sub> "	16" x 14" x 29"
Capacity	2.68 cu. ft.	3.75 cu. ft.
Electrical	110V, 60 HZ, 1.8A	110V, 60 HZ, 2A
Input Power	92W	92W
Power Consumption	1.0KW Hr/24Hrs.	1.2KW Hr/24Hrs.
Refrigerant	R134A - Thermoelectric Cooling	R134A
Ship Weight	90 lbs.	85 lbs.

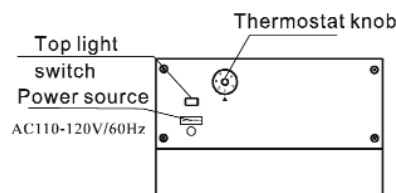
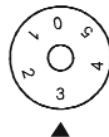
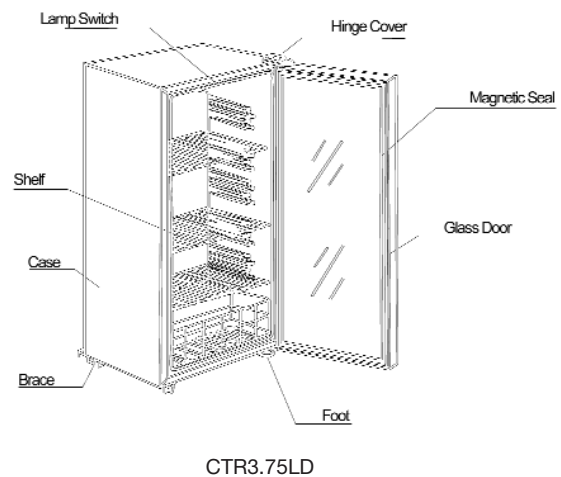
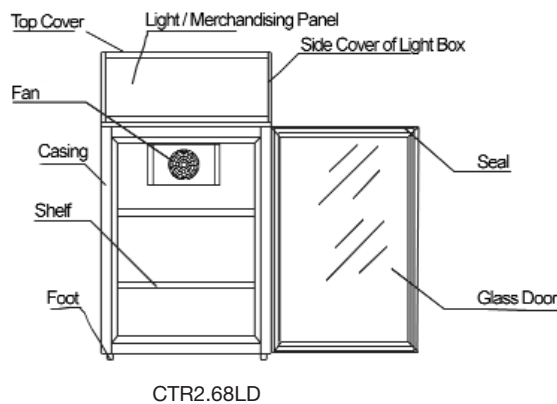



## Setting and Temperature Adjustments

1. Adjust the storage temperature through the temperature controller.
2. The temperature adjustable capacity is from "1"-"5". Adjust the storage temperature by turning the temperature controller clockwise. The "5" setting is for colder storage temperature. The knob can turn freely but can't turn clockwise from "5" to "1". Factory setting position is on "3" position.
3. Check if the knob is on the appropriate position before using. Frequent adjustments is not appropriate when using.
4. Position "0" means refrigerator is off.

# SAFETY PRECAUTIONS 1

- To ensure proper use, please thoroughly study these SAFETY PRECAUTIONS before operating the unit
- The purpose of the safety precautions in this manual is to ensure safe and correct use of the unit, to minimize risks that could cause serious damage and injury to you or other persons. The safety precautions are divided into WARNINGS and CAUTIONS. Cases where improper handling of the unit could lead to death or serious injury are listed under the "⚠ WARNING" heading. However, the cases listed under the "⚠ CAUTION" heading could also lead to serious results. To ensure safety, adhere strictly to both types of safety precautions.









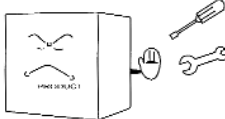

	<b>WARNING</b> Improper handling of the unit could lead to death or serious injury.
	<b>CAUTION</b> Improper handling of the unit could lead to death or serious injury.

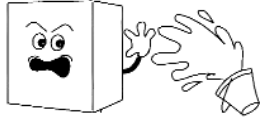
- Text set off by the exclamation mark  contains information that should be strictly adhered to.
- After reading the instruction manual, store it in an easily accessible place where the user(s) of this product can easily find it.

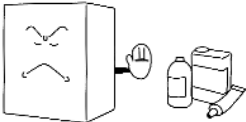
## ◆ PRECAUTIONS FOR INSTALLATION

<b>⚠ WARNING</b>	
	Installation should be performed only by a qualified expert. Attempting to install the unit yourself could result in water leakage, refrigerant leakage, electrical shock, or fire.

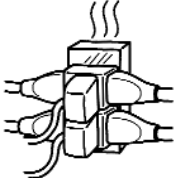
## ◆ PRECAUTIONS FOR USE

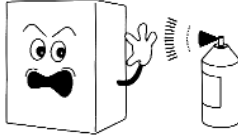
<b>⚠ WARNING</b>	
<p> <b>DON'T TAMPER</b></p> <p>All repairs, disassembly and modifications should be performed only by qualified technicians. Attempting to perform these yourself could result in a fire, malfunction, and injury.</p> 	<p> <b>ELECTRICAL SHOCK HAZARD</b></p> <p>Never splash water directly onto the product or wash with water as short-circuit and electrical leakage could result.</p> 
<p> <b>DANGER OF EXPLOSION</b></p> <p>Never put flammable or volatile substances into the unit as explosion and fire could result.</p> 	<p> <b>PROHIBITED</b></p> <p>Do not damage, modify, excessively bend, strain, twist or bundle up the power cord. Also, placing heavy objects on the power cord or squeezing it into a tight place could damage it, possibly resulting in electrical shock or fire.</p> 
<p> <b>PROHIBITED</b></p> <p>Use a dedicated wall outlet. Do not use extension cords or convenience receptacles as this could result in electrical shock, overheating and a fire.</p> 	<p> <b>FLAMMABLE</b></p> <p>Never use flammable spray cans or leave flammable substances near the unit. Sparks from electrical switches could result in explosion and fire.</p> 

# SAFETY PRECAUTIONS 2

## ⚠️ WARNING



The refrigerator is intended for storage and display of food and beverages for sale. Do not use for other purposes than the intended as this could adversely affect items placed in the unit.



Never attempt to insert fingers, sticks, etc. into the cold air suction outlet. A circulation fan is rotating at a high speed inside the outlet. Injury, electrical shock and improper operation could result.

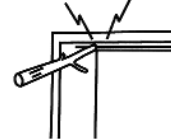

PROHIBITED

For indoor use only. Using the unit in a location exposed to rain could result in electrical leakage and electrical shock.

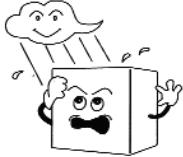

PROHIBITED

Never place heavy objects or items containing water on top of the unit. Objects could fall down and cause injury. Spilled water could deteriorate the insulation of electrical components and result in electrical shortage.



Install the unit in a location where the floor is sturdy enough to support the load of the unit. If the floor is not sturdy enough or installation is incorrectly performed, the unit could tip over and falling shelves and products could cause personal injury.

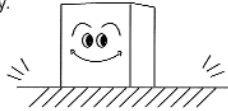

Keep away from hot air sources. Cooling performance is reduced if the unit is placed near heat sources such as hot plates and stoves and if it is exposed to direct sunlight.



Store the unit in a location where it is not exposed to rain. Using a unit that has been exposed to rain could result in electrical shock.

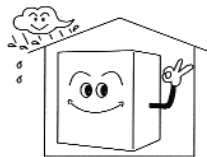

Leave disassembly and disposal of the unit to qualified experts.



Should the unit need temporary storage, make sure not to store the unit in a location where children play and take precautions so that the door cannot be completely closed. This will minimize the risk that a child becomes trapped inside the compartment.

# SAFETY PRECAUTIONS 3

## ⚠ WARNING

### WELL VENTILATED PLACE

Please leave more than 4" space between refrigerator and wall. If there is no space, cooling capacity can drop down.

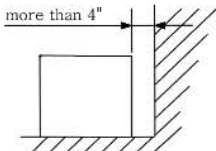

If installation in a damp location is unavoidable, also install an electrical circuit breaker. If circuit breaker is not installed, electrical shock could result.

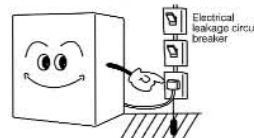

Never hang from the door or climb onto the unit. The unit could tip over or fall and cause material damage or injury.



Disconnect the power cord plug from the wall outlet before moving the unit and make sure that the power cord is not damaged during transport. A damaged power cord could result in electrical shock and/or fire.

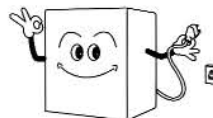

Grasp the handle when closing the door. Holding at other positions could result in pinched fingers and injury.

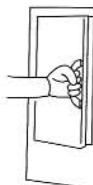

Do not push hand against or apply excessive force to glass surfaces as the glass could break and cause injury.



When disconnecting the power cord plug from the wall outlet, hold at the plug main body close to the outlet. Pulling the cord could cause wire breakage, possibly resulting in overheating and fire.

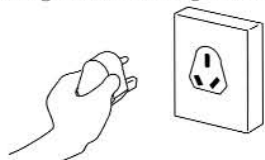

Make sure that the unit does not tip over or fall when it is moved. A falling unit could cause serious injury.

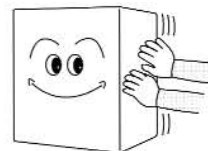

Do not throw items onto the shelves and do not place items totaling more than 30 lbs. on each shelf. The shelf could fall down, possibly causing injury.

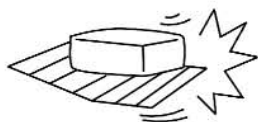

Be sure to attach and secure shelves correctly. An improperly attached shelf could fall down and cause injury.

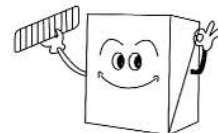

# HOW TO USE

---

## BEFORE USE

- Remove shipping package, tape, etc, and leave doors open to ventilate.
- The unit is cleaned before shipment. However, clean the compartment interior once after delivery.
- Please insert plug into the wall.
- Allow the unit to operate for about 1 hour to cool the compartment before placing items in the cooler.

## WAIT 30 MINUTES BEFORE STARTING

- Restarting the unit immediately after it has been turned off may cause fuses to blow and activate the circuit-breaker; the compressor may be overloaded, and/or other damage may occur.

## TEMPERATURE ADJUSTMENT

- The thermostat was adjusted at the factory. To adjust it, turning right will cause temperature to become colder. To raise the temperature, turn it left. Excessive refrigeration will increase electricity consumption unnecessarily.

## DRAIN TRAY

- Defrosting is performed automatically and drain water is collected in the drain tray.

## EFFICIENT USE

Please follow the instruction below.

- To prevent cold air from escaping, open and close the door quickly and keep the door opened for as short a time as possible.
- Please install the unit in a place which is well-ventilated.

## SHELF HEIGHT ADJUSTMENT

The shelf height can be adjusted.

Arrange the shelves in accordance with the dimensions of the items to be placed in the cooler.



# 1 EXTERIOR & COOLING COMPARTMENT

Wipe with a soft, dry cloth. If very soiled, wipe with a cloth that has been moistened with a detergent. Then wipe with a cloth that has been dipped in water.



**WARNING**

**WARNING:** Do not splash water directly onto the cooler and do not wash with water. Short-circuit and electrical shock could result.

- Clean the cooler regularly.
- Never use polishing powder, soap powder, benzine, oil or hot water as these will damage the painted and plastic components.

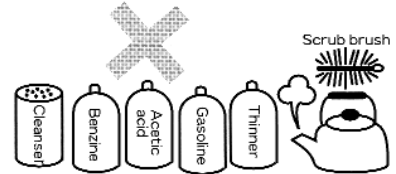

## 2 CHECKS

To ensure safety, perform the following checks after cleaning:

- Is the power cord plug firmly inserted into a dedicated wall outlet? Confirm that the plug is not abnormally hot.
- Check the power cord for cracks and damage. Should the slightest irregularity be observed, contact the dealer from whom you purchased this unit from or our customer service department.

# IN CASE OF THE FOLLOWING

---

## 1 POWER FAILURE

- Keep opening and closing of the door to a minimum.
- Avoid placing new items in the cooler as this will raise the temperature inside the compartment.

## 2 ABOUT CORD

- If the supply cord is damaged, it must be replaced by a special cord or assembly available from the manufacturer or the service agent.
- The refrigerator must be positioned so that the plug is accessible.

## 3 WHEN NOT USED FOR A LONG PERIOD

- Remove all items from the compartment and disconnect the power cord plug from the wall outlet.
- Clean the compartment interior and wipe away all water.
- To prevent mold formation and bad smell, leave the door open to dry the compartment completely.

## 4 TRANSPORTATION

- Disconnect the power cord plug from the wall outlet.
- When moving the cooler, make sure that the feet do not damage the power cord.
- Do not let the feet hit against floor steps, thresholds, etc.

## 5 TEMPORARY STORAGE

- Affix a piece of wood, etc. between the door and main unit to prevent complete closing of the door.
- Make sure not to store the unused cooler at a location where children play.
- Should a child enter the compartment and the door is closed, the child may not be able to open the door from the inside.



## **Portability and storage**

1. Keep the unit vertical when carrying the unit, the angle to the horizontal line should not be over 50°, otherwise it will damage the compressor and affect normal operation of the unit.
2. Adjust the height with all the four feet adjusted.
3. After moving the unit, let it stand for 30 minutes before switching it on.
4. Running: close the door and connect the power. Turn on the light switch. The temperature should be suitable for normal use after half hour.
5. After connecting the power, the unit should be kept empty for one hour.

## **Maintenance**

Disconnect the power supply before performing maintenance on the machine!

1. Keep the door gasket clean, remove it from the door and wash it. Dry and seal it as before. Putting some talcum powder on the magnetic surface would prolong its service life.
2. Light replacement: remove the top cover, take out the light, replace with a new light, then mount it again.
3. Use a soft cloth and dip some water or soap (Non-caustic, neutral detergent is also available) to clean the unit. Dry the unit after cleaning to avoid rust.
4. Do not use organic liquid, boiled water, washing powder or acid products to clean the unit. Rinsing the case with water is not allowed. Do not use a hard brush to clean the case.
5. If the unit will not be used for a long time, disconnect the power, clean it by following the above steps, wipe off the water inside the case with a soft cloth. Discard the water in the water plate.

## **Caution**

1. The unit is not suitable for storage of blood, pharmaceutical products and biological products
2. Do not place heavy articles on the top of the unit.

# BEFORE REQUESTING SERVICE

<p>No refrigeration at all</p>	<ul style="list-style-type: none"> <li>● Is the power supply interrupted?</li> <li>● Is the power cord plug disconnected from the wall outlet?</li> <li>● Are the shop's power fuses blown and/or the circuit breaker activated?</li> </ul>
<p>Inadequate refrigeration</p>	<ul style="list-style-type: none"> <li>● Is the temperature setting appropriate?</li> <li>● Are items obstructing the cold air inlet and suction outlet?</li> <li>● Are stored items packed too tight?</li> <li>● Is the door open or is it opened and closed frequently?</li> <li>● Is the condenser clogged?</li> </ul>
<p>Excessive noise</p>	<ul style="list-style-type: none"> <li>● Are all feet in firm contact with the floor?</li> <li>● Is the rear panel of the cooler contacting the wall or other objects?</li> <li>● Are other objects in contact with the cooler?</li> </ul>
<p>Condensation on cooler exterior</p>	<ul style="list-style-type: none"> <li>● Condensation may form on the exterior of the door during hot and humid days or depending on the place of installation. This occurs when the humidity is high and water particles in the air contact cold surfaces. This is normal. Wipe away condensation with a dry cloth.</li> </ul>

Showcase sometimes stop running when thermostat turns off.

# REQUIRED INFORMATION

Before calling for service, please have the following information available:

- |  |   |                      |   |
|--|---|----------------------|---|
| <ul style="list-style-type: none"> <li>① Nature of malfunction<br/>(as accurately as possible)</li> <li>② Product number</li> <li>③ Serial number</li> </ul> | } | (inscribed on badge) | <ul style="list-style-type: none"> <li>④ Customer's name, address,<br/>phone number</li> <li>⑤ Year and date of purchase</li> <li>⑥ Desired date for service visit</li> </ul> |
|--|---|----------------------|---|

# Graphic Templates

SIDE PANEL GRAPHIC: CTR 2.68LD

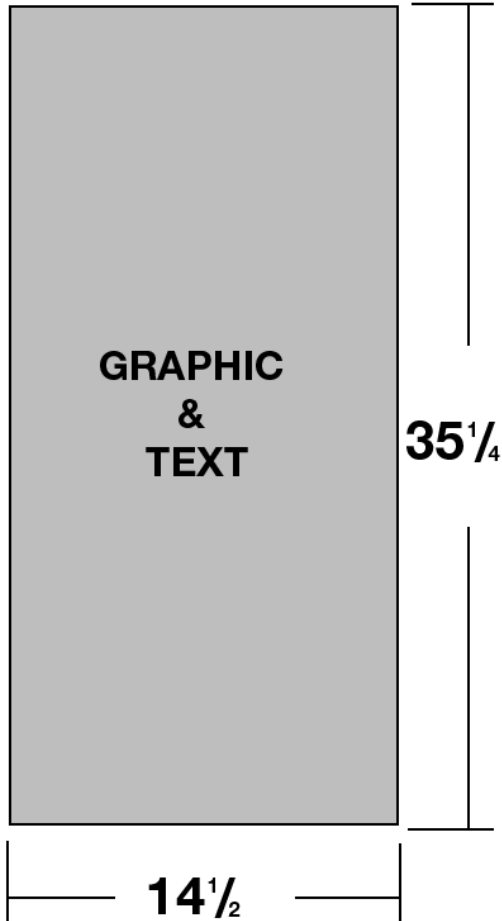

LAMP BOX GRAPHIC: CTR 2.68LD

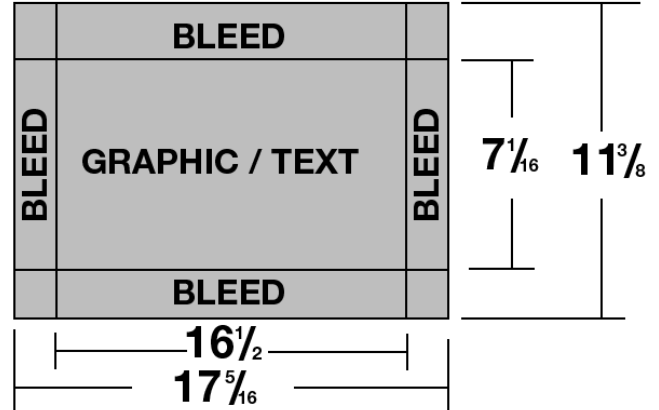

## Data Label / Wiring Diagram

<p>NAME: Display cooler</p> <p>MODEL: CTR3.75</p> <p>SOURCE: 110-120V 3099945</p> <p>FREQUENCY: 60 Hz CONFORMS TO ILL. STD. 471, NSF7</p> <p>AMPS: 2.0 A CERTIFIED TO CSA C22.2NO.120</p> <p>LAMP POWER: 8W</p> <p>REFRIGERANT: R134A DESIGN PRESSURE HIGH SIDE: 280 psig LOW SIDE: 90 psig</p> <p>CHARGE: 2.29 oz</p> <p>SERIAL NO:</p>	<p style="text-align: center;">Electric Wiring diagram</p>
<p>CECILWARE CORPORATION. MADE IN CHINA</p>	
<p><b>WARNING</b></p> <p>1. This equipment is intended for the storage and display of non-potentially-hazardous bottled or canned products only.</p> <p>2. This equipment is intended for the storage and display of packaged products only.</p>	

<p>NAME: Display cooler</p> <p>MODEL: CTR2.68LD</p> <p>SOURCE: 110-120V 3099945</p> <p>FREQUENCY: 60 Hz CONFORMS TO ILL. STD. 471, NSF7</p> <p>AMPS: 1.8A CERTIFIED TO CSA C22.2NO.120</p> <p>LAMP POWER: 8W</p> <p>REFRIGERANT: R134A DESIGN PRESSURE HIGH SIDE: 280 psig LOW SIDE: 90 psig</p> <p>CHARGE: 1.76oz</p> <p>SERIAL NO:</p>	<p style="text-align: center;">Electric Wiring diagram</p>
<p>CECILWARE CORPORATION. MADE IN CHINA</p>	
<p><b>WARNING</b></p> <p>1. This equipment is intended for the storage and display of non-potentially-hazardous bottled or canned products only.</p> <p>2. This equipment is intended for the storage and display of packaged products only.</p>	

## Spare Parts List

Part #	Model #	Description	List Price
08711	CTR2.68-LD, CTR3.75	Big Foot	\$ 3.50
08726	CTR3.75	Bottom Basket Shelf	9.30
08705	CTR2.68-LD	Canopy logo plastic	12.30
08707	CTR2.68-LD, CTR3.75	Compressor	172.20
08708	CTR2.68-LD, CTR3.75	Dryer	4.90
08709	CTR3.75	Fluorescent lamp	6.20
08710	CTR2.68-LD	Fluorescent lamp	9.20
08716	CTR2.68-LD	Glass door	55.40
08717	CTR3.75	Glass door	67.60
08718	CTR2.68-LD, CTR3.75	Hinge Bottom	3.10
08720	CTR2.68-LD, CTR3.75	Hinge Upper	3.10
08735	CTR1.75LD, CTR3.75	Inner Light	6.20
08731	CTR2.68-LD, CTR3.75	Key to Lock	3.10
08730	CTR2.68-LD, CTR3.75	Lock	3.10
08721	CTR2.68-LD, CTR3.75	Power Supply Cord	9.30
08725	CTR2.68-LD	Shelf	6.20
08727	CTR3.75	Shelf	9.20
08728	CTR2.68-LD	Side canopy cover left	4.90
08729	CTR2.68-LD	Side canopy cover right	4.90
08712	CTR2.68-LD, CTR3.75	Small Foot	3.10
08701	CTR2.68-LD, CTR3.75	Switch	3.10
08703	CTR2.68-LD, CTR3.75	Thermostat	9.80

Specifications are subject to change without prior notice; prices valid until December 31, 2009

**Cecilware Corporation** 43-05 20th. Avenue, LIC NY 11105  
 Tel: 800.935.2211 / 718.932.1414 • Fax: 718.932.7860  
 E-mail: customer.service@cecilware.com

