

## SM367203W

### Components:

#### Panels:



(2) Floor Panels  
(open hole sockets)

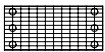

(1) 1st Level  
(closed hole sockets)



(2) 2nd and 3rd Levels  
(open center hole sockets)

#### Legs:

- (8) - 12"
- (2) - 24"
- (2) - 36"
- (4) - 72"

**Oil All Sockets  
Before Assembly**

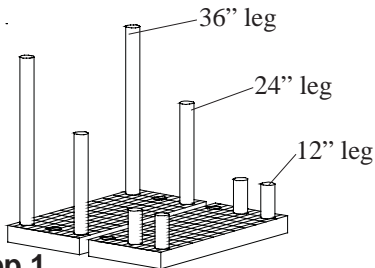

### Step 1

#### Floor Level

Place legs as shown.  
Push legs through to ground.

### Fully Assembled

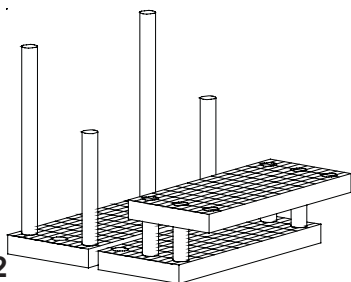
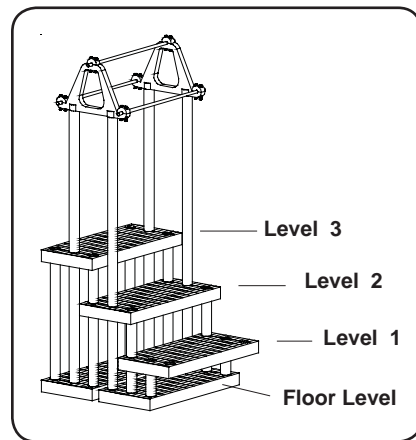

### Step 2

#### Level 1

Position the Level 1 Panel on 12" legs  
overhanging outside edge as shown.

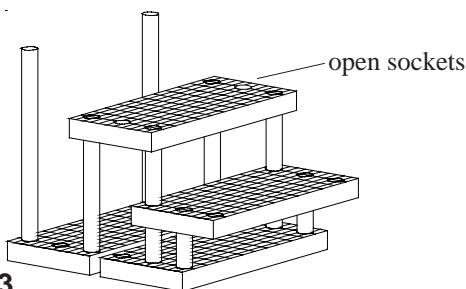

### Step 3

#### Level 2

- A. Invert Level 2 panel and place  
(2) 12" legs in outside sockets.
- B. Position panel on 24" legs  
while placing 12" legs on the Level 1 panel.  
Push panel down so that the 24" legs are  
seated in the sockets.

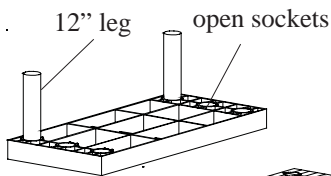
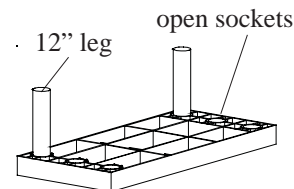

### Step 4

#### Level 3

- A. Invert Level 3 panel and place  
(2) 12" legs in outside corners.
- B. Position panel on 36" legs while placing 12"  
legs on the Level 2 panel. Push panel down so  
that the 36" legs are seated in the sockets.

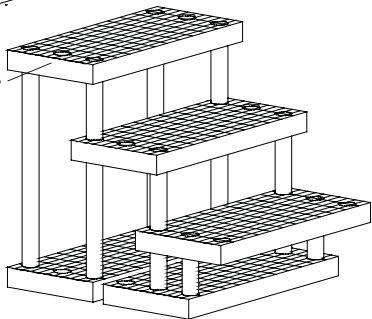

72" leg

**Oiling the sockets will  
make this step easier.**

### Step 5

#### Plant Hanger

Insert 72" legs into center open hole  
sockets of Levels 3 and 2. Slide legs all  
the way through open hole sockets in floor  
panels. (Make sure to push legs all the  
way down to the floor).

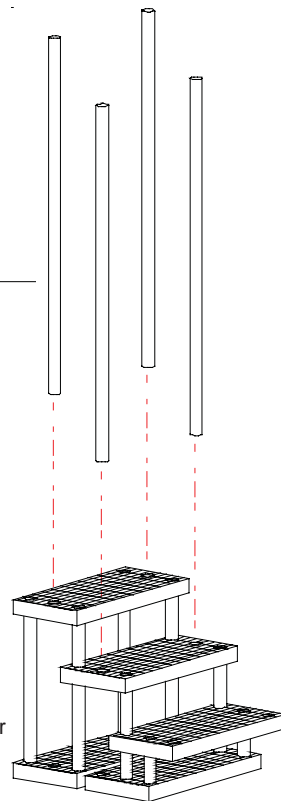

# ASSEMBLY INSTRUCTIONS

## SM367203W

Oil All Sockets  
Before Assembly

|                         |
|-------------------------|
| <b>Components:</b>      |
| Plant Hanger Tops: 2    |
| Plant Hanger Collars: 6 |
| Plant Hanger Poles: 3   |
| Bolts: 12               |
| Wingnuts: 12            |

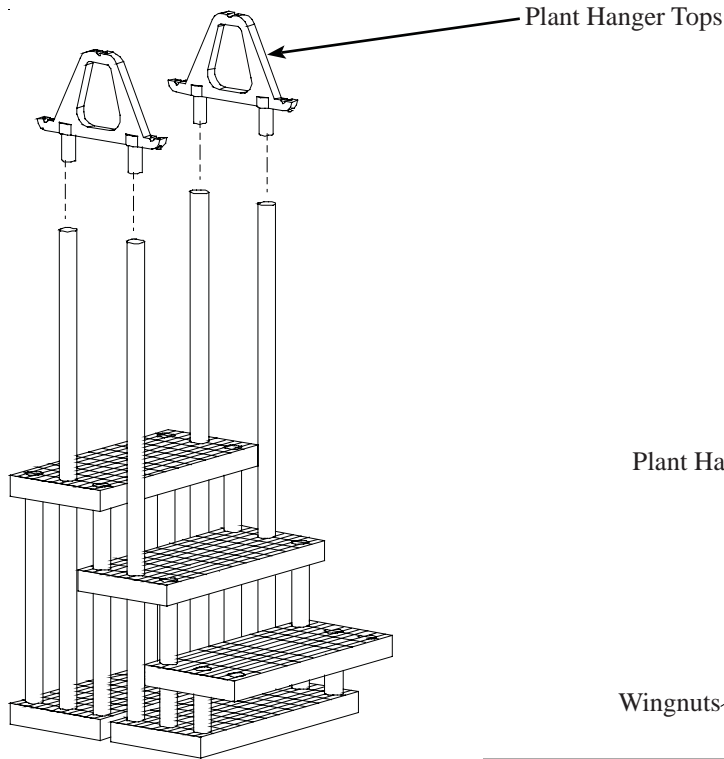

### Step 6

#### Plant Hanger

Insert Plant hanger tops in 72" legs as shown.

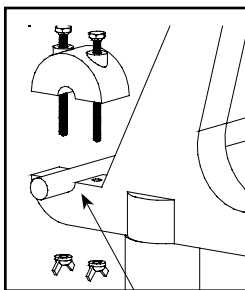

Groove for  
Plant Hanger  
Poles

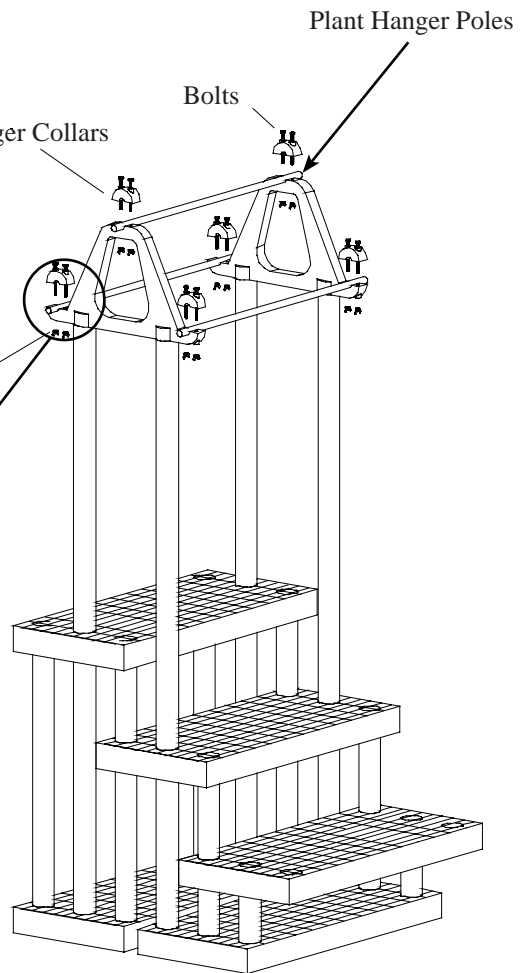

### Step 7

#### Plant Hanger

Next, place 36" plant hanger poles into small groove in plant hanger top. Place plant hanger collars over poles and fasten down with bolts and wingnuts.