



Outperform every day.™

Project:
Item Number:
Quantity:

Mirage® 16" x 23" Induction Buffet Warmers

The Vollrath Company, L.L.C.

MIRAGE® 16" X 23" INDUCTION BUFFET WARMERS



ITEMS

Item No.	Model No.	Description
5950875		Countertop, Black (US/Canada)
5950880	59508XX	Countertop, Natural (US/Canada)
59508DW		Drop-in, F(US/Canada)

FEATURES

- Connect up to three warmers with the included interconnect cords. The center warmer must connect to the electrical outlet.
- Up to four warmers (at maximum power) can be connected to a 15 amp circuit
- Compartment under warmer stores cords when not in use
- Touch controls
- Four power levels
- LED indicator lights on control panel and glass top
- Tempered black ceramic glass top is strong, non-porous and easy to clean
- Low profile design puts the focus on the food and compliments any decor
- Drop-in warmers can be installed overhanging countertop or countersunk
- 6 ft. (183 cm) cord with plug
- 37½ in. (95 cm) interconnect cord
- 5 ft. (152.4 cm) USB cable for remotely mounted control box for drop-in warmers

DESCRIPTION

Maximize your menu offerings without maxing out your electrical capacity with the Mirage® 16" x 23" Induction Buffet Warmers. The low wattage warmers can be interconnected to one electrical outlet, which simplifies the planning and management of power cords, access to outlets and load capacity. Available in countertop and drop-in styles, these warmers are ideally suited for buffet and catering operations

These induction buffet warmers are designed to work with a maximum of one induction-ready chafer or serving vessel.

The Mirage® 16" x 23" Induction Buffet Warmers are equipped with a variety of safety features including:

- Over-heat protection
- Small-article detection
- Pan auto-detection function
- Empty-pan shut-off

AGENCY CERTIFICATIONS



This device complies with Part 18 FCC Rules.

Due to continued product improvement, please consult www.vollrath.com for current product specifications.

WARRANTY

All models shown come with Vollrath's standard warranty against defects in materials and workmanship. For full warranty details, please refer to www.Vollrath.com.

ACCESSORIES

- 4644070 Non-Slip Mat for 16" x 23" Warmers

CLEARANCE AND ENVIRONMENT REQUIREMENTS

- Countertop models require a distance equal to the height of the feet of the warmer.
- Drop-in models require a minimum of 2" (5 cm) of space between all four sides of the induction warmer and any surrounding surface, and a minimum 12" (30.5 cm) between the bottom of the induction warmer and any surrounding surface.
- Control box for drop-in models requires a minimum of 4" (10 cm) behind the control box and any surrounding surface.
- All models require unrestricted intake and exhaust air ventilation for proper operation of the controls. The maximum intake temperature must not exceed 110°F (43°C). Temperatures are measured in ambient air while all appliances in the kitchen are in operation.

Approvals	Date



Outperform every day.™

www.vollrath.com

The Vollrath Company, L.L.C.

1236 North 18th Street
Sheboygan, WI 53081-3201 U.S.A.
Main Tel: 800.624.2051 or 920.457.4851
Main Fax: 800.752.5620 or 920.459.6573
Customer Service: 800.628.0830
Canada Customer Service: 800.695.8560

Technical Services

techservicereps@vollrathco.com
Induction Products: 800.825.6036
Countertop Warming Products: 800.354.1970
All Other Products: 800.628.0832

MIRAGE® 16" X 23" INDUCTION BUFFET WARMERS

DIMENSIONS (Shown in inches (cm))

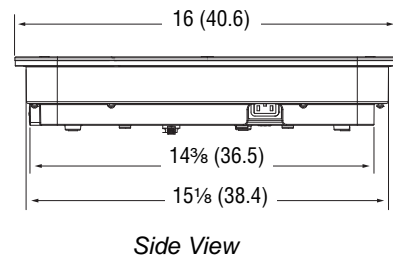
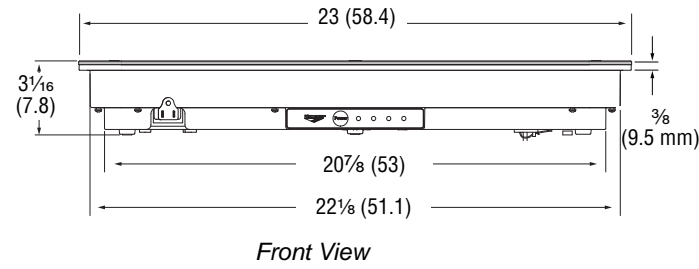

Drop-in Model, Overhung Installation

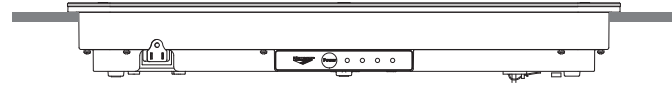

Drop-in Model, Countersunk Installation

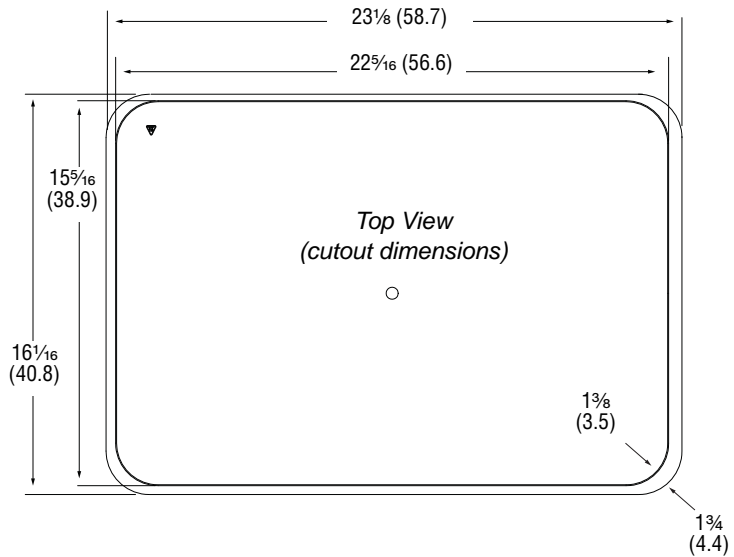
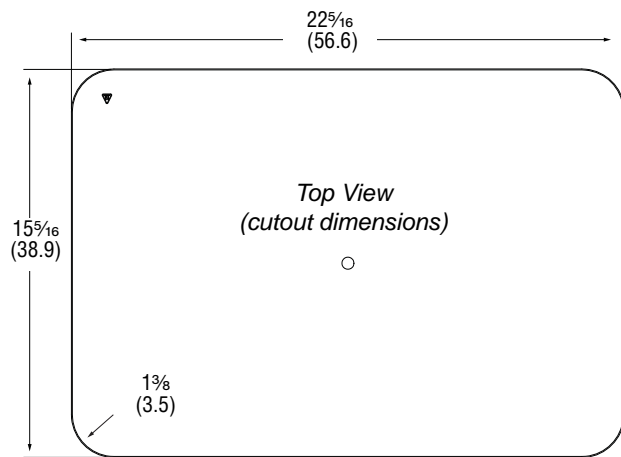
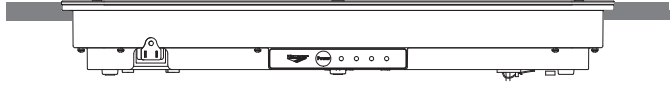

Control Box (drop-in models only)

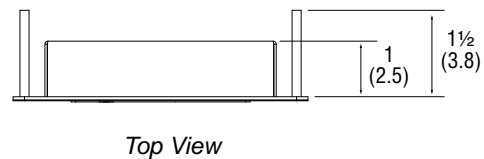
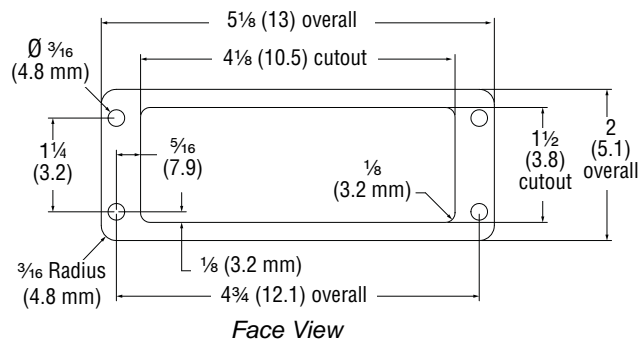

SPECIFICATIONS

Item No.	Description	Max Pan Size IN (CM)	Watts	Volts	Amps	Hz	Plug	Weight LB (KG)
5950875	Countertop, Full-Size, Black	10 1/4 x 17 1/4 (26 x 43.8)	375	120	3.15	50/60	NEMA 5-15P	14.9 (6.8)
5950880	Countertop, Full-Size, Natural							
59508DW	Drop-in, Full-Size							

Receptacle

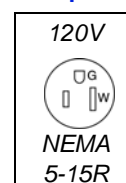

Outperform every day.™

www.vollrath.com

The Vollrath Company, L.L.C.

1236 North 18th Street
Sheboygan, WI 53081-3201 U.S.A.
Main Tel: 800.624.2051 or 920.457.4851
Main Fax: 800.752.5620 or 920.459.6573
Customer Service: 800.628.0830
Canada Customer Service: 800.695.8560

Technical Services
techservicereps@vollrathco.com
Induction Products: 800.825.6036
Countertop Warming Products: 800.354.1970
All Other Products: 800.628.0832