

INSTALLATION INSTRUCTIONS

ABC7G & ABC7E COMBI STACKING KIT

STACKING KIT PART NO. 00-947491 (GAS) & 00-947343 (ELECTRIC)

NOTICE Safety standards require that, when the combi oven's gas supply is properly connected, an adequate means must be provided to limit movement of the oven without applying stress to the gas supply line. This means that, as part of the installation, the oven must be secured to either the wall or the floor to limit movement of the oven and, thus, preventing damage to the flexible gas supply line during cleaning, maintenance and service operations.



WARNING Disconnect the electrical power to the machine and follow lockout / tagout procedures.

KIT CONTENTS FOR 00-947491 (GAS) AND 00-947343 (ELECTRIC)

COMMON PARTS (BOTH KITS)		
Part Number	Description	Quantity
00-973006*	TEE 1" TUBE	1
00-973025	TUBE, CAVITY VENT, STACKED	1
00-973026	TUBE, CAVITY EXHAUST, STACKED	1
00-947230	HOSE, CONNECTION, STACKED CAVITY IN-TAKE/EXHAUST	2
00-947231	CLAMP, HOSE, 1.813" - 2.750" OD	4
00-947232*	CLAMP, HOSE, 0.813" - 1.75" OD	4
00-947346*	TUBE, DRAIN VENT	1
00-947485	SCREW, FLANGE HD, 3/8-16 X 1.0"	18
00-947494	DRIP TRAY	1
00-947549	CASTER, SWIVEL, FRONT	2
00-947550	CASTER, RIGID	2
00-947593	SLEEVING, FIBERGLASS, 2-1/2" ID, BLUE	1
00-973048	CLAMP, HOSE, 1-7/8" - 5.0" OD	2
00-947675	ASSEMBLY, FLU, STACKED, UPPER	1
00-947676	ASSEMBLY, FLU, STACKED, BTM	1
00-973022	SUPPORT, DRIP TRAY, CASTER	1
00-947703	BRACKET, RESTRAINT	2
00-973030	LIFT SUPPORT BLOCKS	2
00-973068	CARABINEER	1
00-973067	LANYARD	1

* Not required for units starting SN 541083579

KIT CONTENTS FOR 00-947491 (GAS ONLY)		
Part Number	Description	Quantity
00-947675	ASSEMBLY, FLU, STACKED, UPPER	1
00-947676	ASSEMBLY, FLU, STACKED, LOWER	1

TOOLS

- Fork lift or Floor Jack

ABC7 COMBI OVEN - COVERS LOWER AND UPPER UNITS (Both Gas and Electric)

1. Remove four right panel screws.
2. Lift right panel up and back using handles.

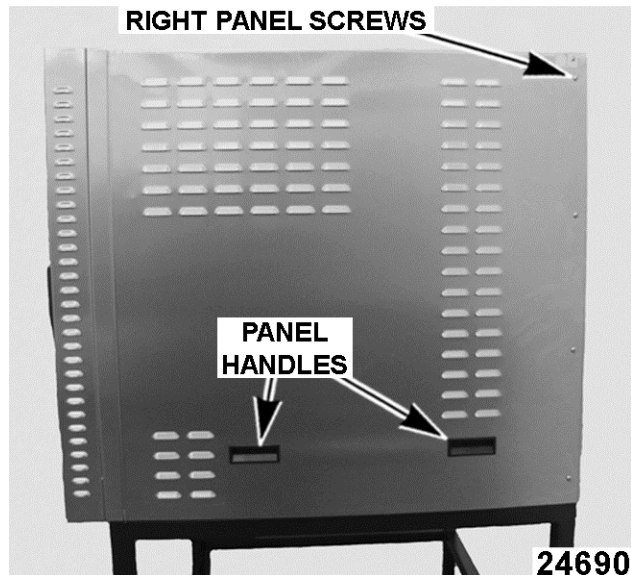

Fig. 1

3. Remove two fan screws.

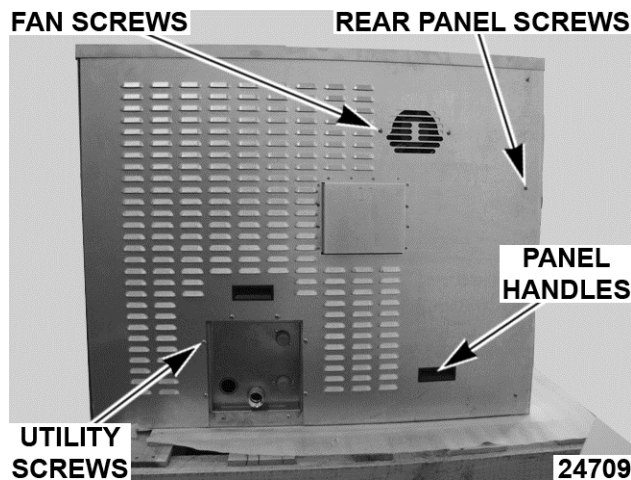

Fig. 2

4. Remove six utility panel screws.

NOTE: Lower two utility screws only support utility cover and can be left assembled.

5. On the right side, remove screw in the upper right hand corner.

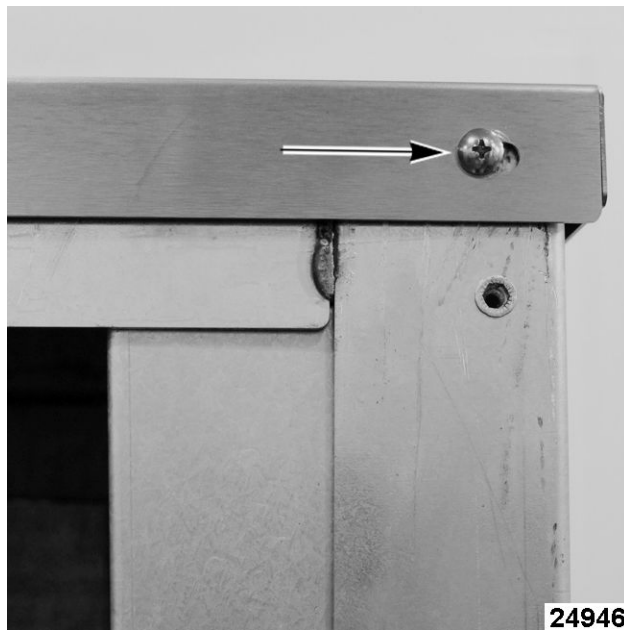

Fig. 3

6. Remove four rear cover screws.

NOTE: Hold on to panel handle to prevent rear panel from falling.

7. Lift with handles to remove.

ABC7 COMBI OVEN - STACKING KIT PREPARATION (Both Gas and Electric)

1. Remove all wire racks and set aside.
2. Remove cavity fan baffle and set aside.
3. **UPPER UNIT:** Remove vent knockouts on top of unit.



Fig. 4

4. **UPPER UNIT:** Remove vent knockout on bottom of upper unit.

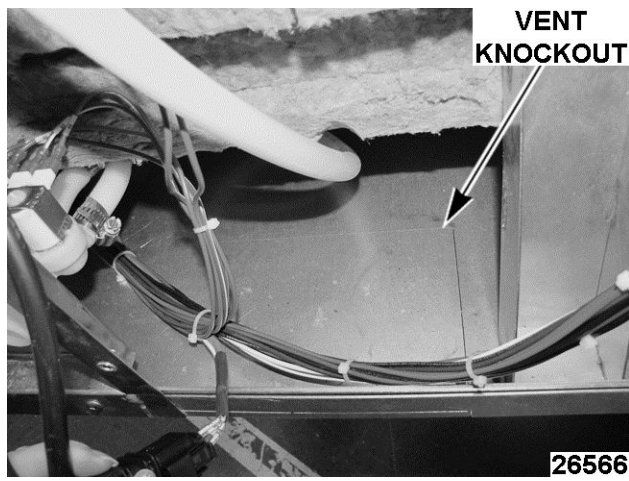

Fig. 5

5. **LOWER UNIT:** Remove mounting knock-outs in front right and back left on top cover of lower unit.

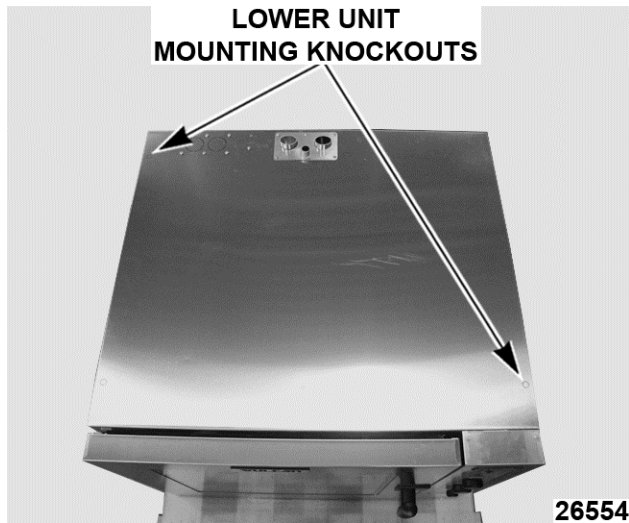

Fig. 6

NOTE: For gas units, continue to [ABC7 Combi Oven - Stacking Kit Preparation \(Gas ONLY\)](#).

NOTE: For electric units, proceed to [Caster Install - Lower Unit](#).

ABC7 COMBI OVEN - STACKING KIT PREPARATION (Gas ONLY)

1. **BOTH UNITS:** Carefully remove insulation from rear heat shield.

NOTE: This insulation will be reinstalled later.

2. **UPPER UNIT:** Remove gas flue knockouts on lower part of unit.

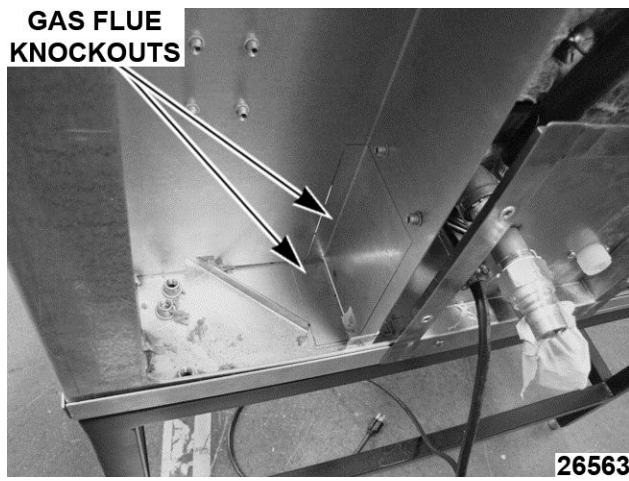

Fig. 7

3. LOWER UNIT:

- Before SN 541083579 - Remove flue cap, gasket and stacked flue knockout.
- After SN 541083579 - Remove stacked flue knockout.

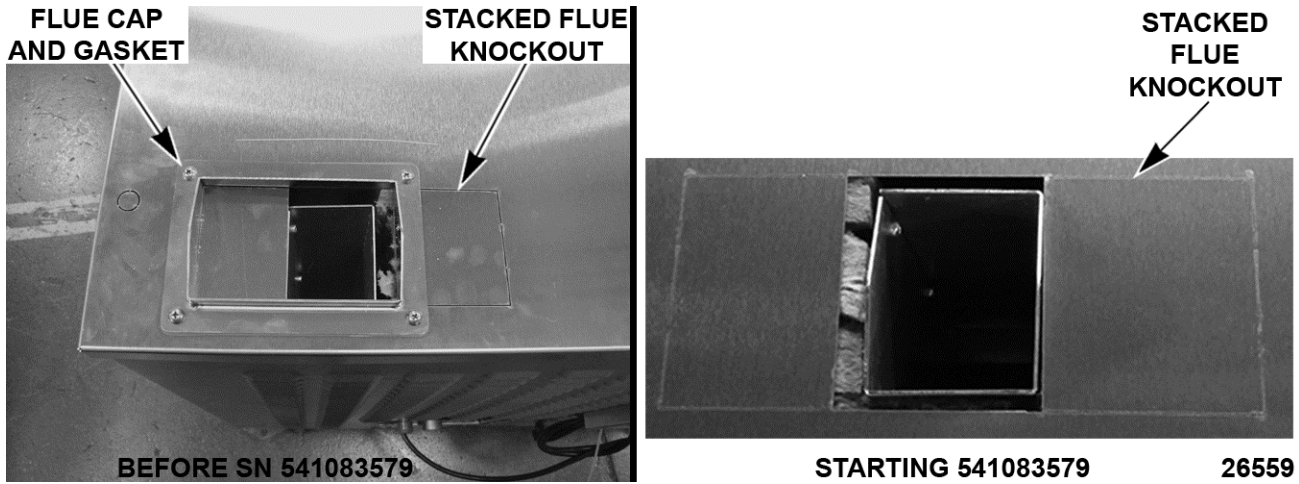
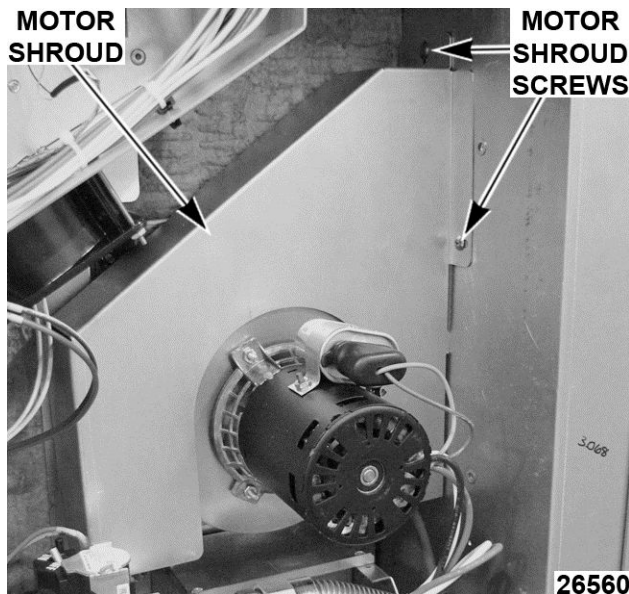

Fig. 8

4. LOWER UNIT: Remove motor shroud.



Motor Shroud

- 5. **LOWER UNIT:** Remove gas flue screws.
- 6. **LOWER UNIT:** Remove gas flue from back of unit.

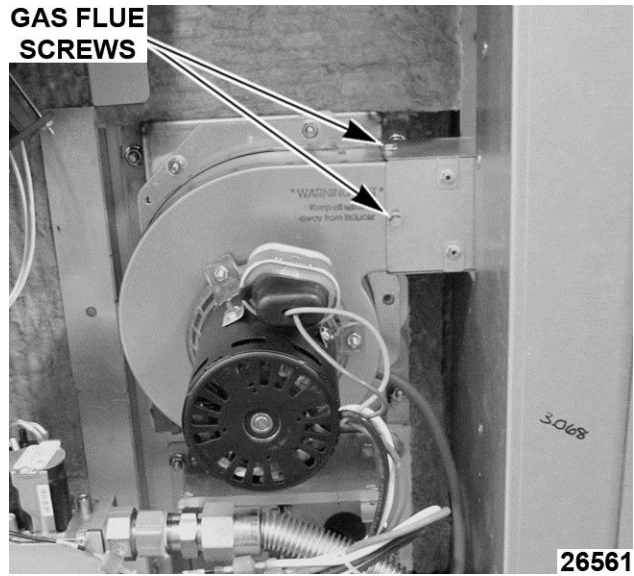

Inducer Blower Motor

- 7. **LOWER UNIT:** Remove inducer blower vent heat shield knockout.

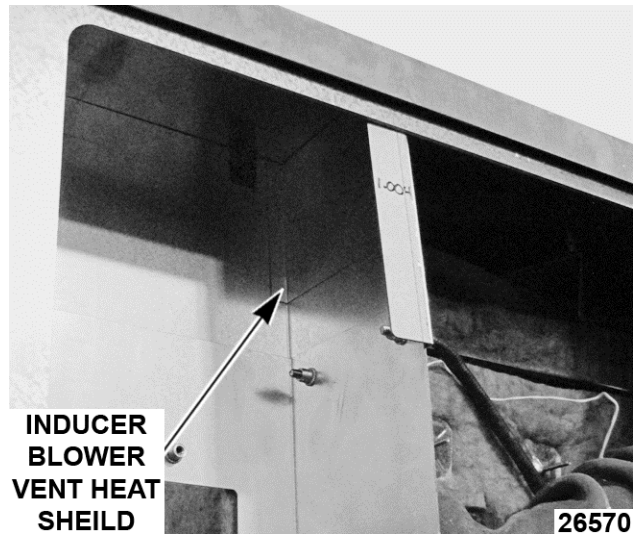

Fig. 11

- 8. **LOWER UNIT:** Insert lower stacked flue assembly through inducer blower vent heat shield and stacked flue knockout.

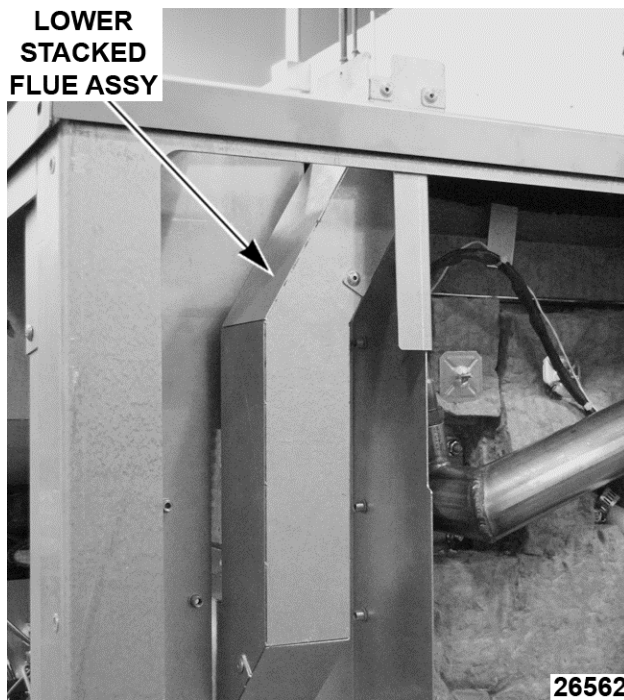

Fig. 12

9. **LOWER UNIT:** Connect lower stacked flue assembly to inducer blower motor. Inducer Blower Motor.
10. **LOWER UNIT:** Install motor shroud. Motor Shroud.
11. **UPPER UNIT:** Insert upper top stacked flue assembly to upper unit.

NOTE: Push upper top stacked flue assembly to the side, so that it does not protrude through bottom of unit or cause damage during stacking install.

NOTE: Removing upper flue stack will ease installation of upper top stacked flue assembly.

CASTER INSTALL - LOWER UNIT

1. Raise Lower unit.

NOTE: Use forklift if available instead of floor jack.



Fig. 13

2. Attach swivel casters and drip tray to front of lower machine using 8 screws, 4 each side.

NOTE: Use forklift if available instead of floor jack.

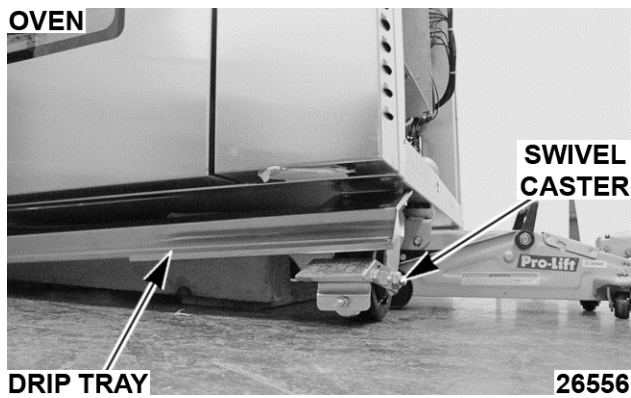

Fig. 14

3. Attach non-swivel casters to back of lower unit with 8 screws, 4 each side.

NOTE: Use forklift if available instead of floor jack.

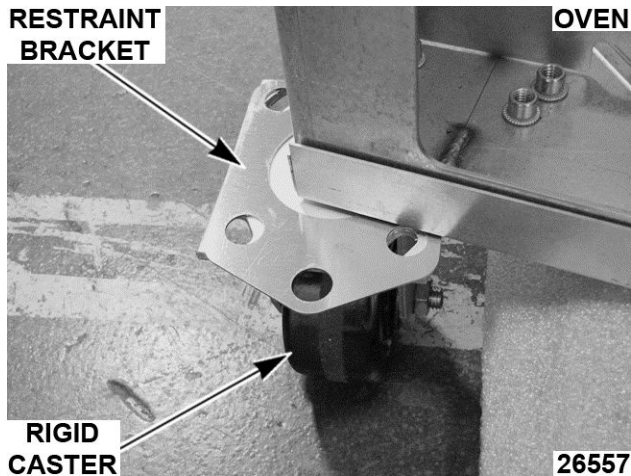

Fig. 15

STACKING OVENS (Both Gas and Electric)

1. Place Styrofoam™ lift support blocks (included in kit) on forks.

NOTE: Forks should be placed approximately 20" apart.

NOTE: Use support blocks as gauges. Place blocks at tips of forks.

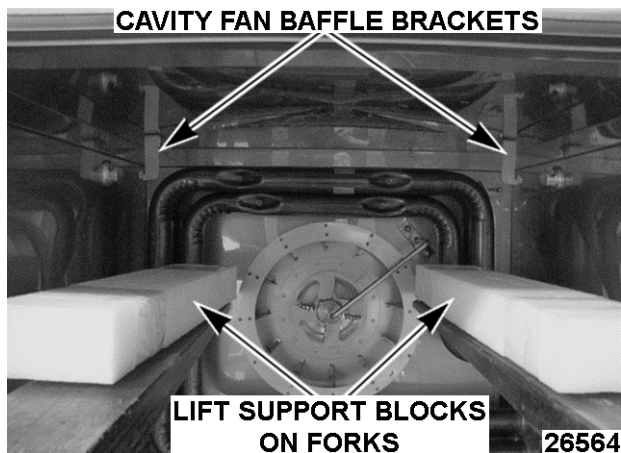

Fig. 16

2. Slowly insert forks in upper unit.

NOTE: Verify forks do not touch cavity fan baffle brackets or the cavity fan.

3. Slowly lift forks to raise upper unit over lower unit.

NOTICE Verify lift support blocks are between the cavity fan baffle brackets and front lip of ceiling. Not doing so may cause damage.

NOTICE When lifting upper unit, hold door so door does not swing open and break.



Fig. 17

4. Move lower unit under raised upper unit.
5. Slowly lower the upper unit onto the lower unit.

NOTE: Verify the lower flue stack is inserted into the flue stack knockout on upper unit (gas **ONLY**).

NOTE: Verify the lower vent stack is inserted into the vent stack knockout on upper unit.

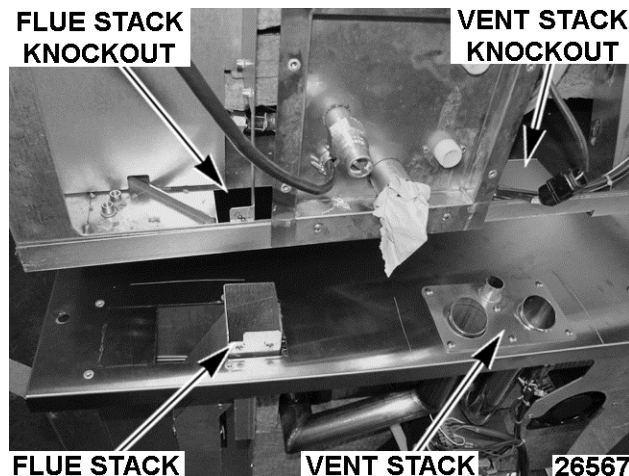

Fig. 18

6. Mount upper unit onto lower machine and attached using flange head screws.

NOTE: Two screws will be inserted up through the upper panel of the lower unit and fastened in place.

7. Attach upper stacked flue assembly to lower flue stack with screw.

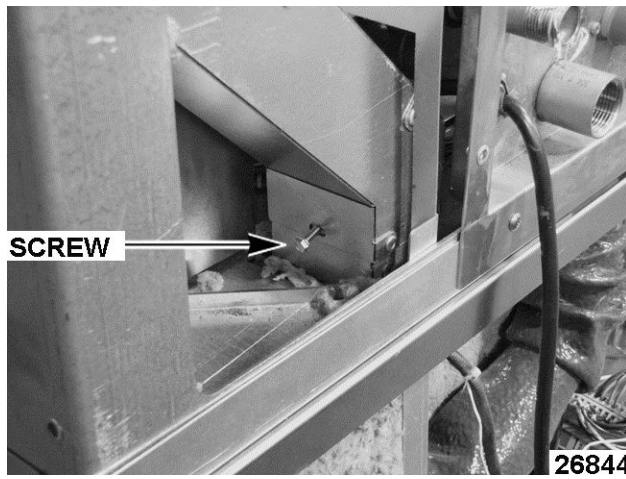

Fig. 19

8. Reinstall insulation removed earlier. Cut as needed.

ABC7 - CAVITY INTAKE AND EXHAUST VENT ASSEMBLIES (Gas and Electric, Upper Unit ONLY)

NOTE: Drain vent assembly procedure not required for units starting SN 541083579.

1. Insert drain vent tube (supplied with stacking kit) onto bottom unit drain vent flange and secure with hose clamp.
2. Insert drain vent tube onto 1" tube tee and secure with hose clamp.



Fig. 20

3. Bend drain vent tube as shown cut 1" section from upper unit drain vent tube.

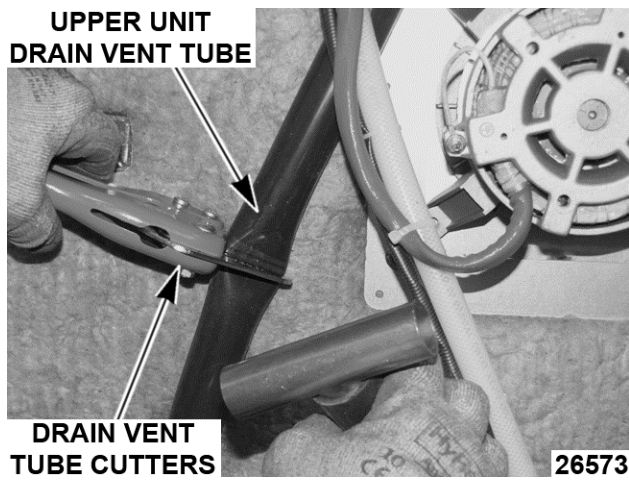

Fig. 21

4. Insert both ends of upper cut drain tube onto Tee and secure with hose clamps.

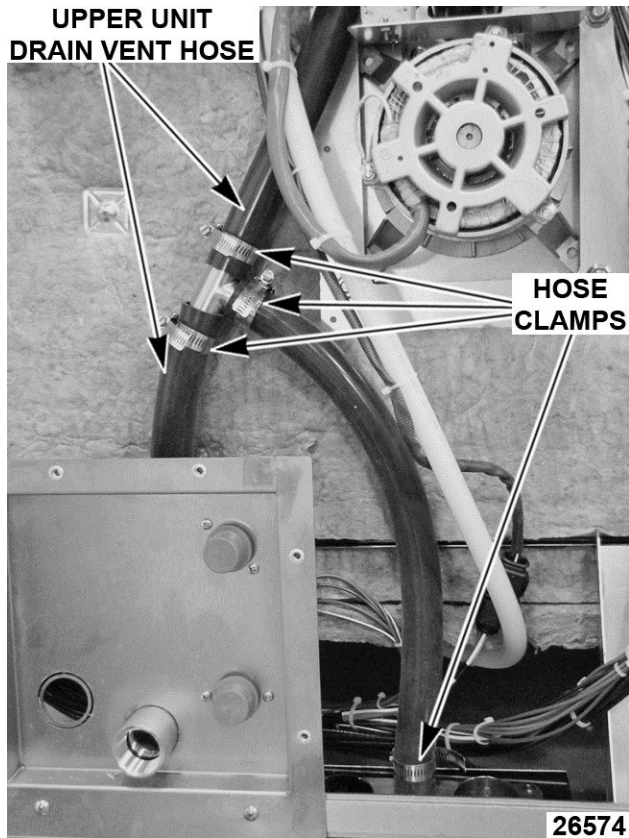

Fig. 22

1. Place two of the large hose clamps on each of the connecting hoses provided in the stacking kit.
2. Place the connecting hoses on the intake and exhaust vents coming up from the lower unit.

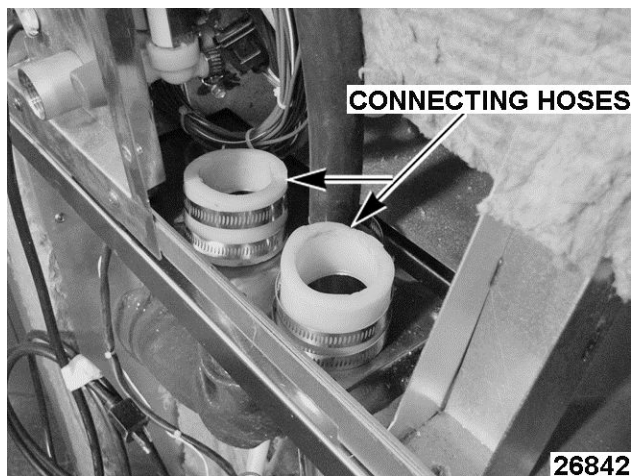

Fig. 23

3. Remove screw on the left hand side that is securing the top to the unit.
4. Install the exhaust pipe into the connecting hose on the left and out the left vent knockout in the top.

NOTE: The exhaust pipe is insulated.

5. Install the intake pipe into the connecting hose on the right and out the right vent knockout in the top.

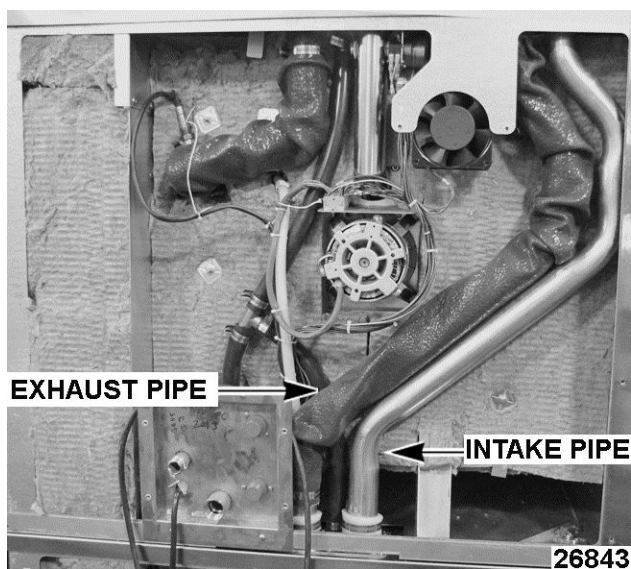

Fig. 24

6. Tighten the hose clamps on each vent to secure the connecting hoses.
7. Replace panels and check for proper operation.

ABC7 - REVERSING DOOR HANDLE (Gas and Electric, Lower Unit ONLY)

1. Open oven door.
2. Unlatch inner door using inner door latch.

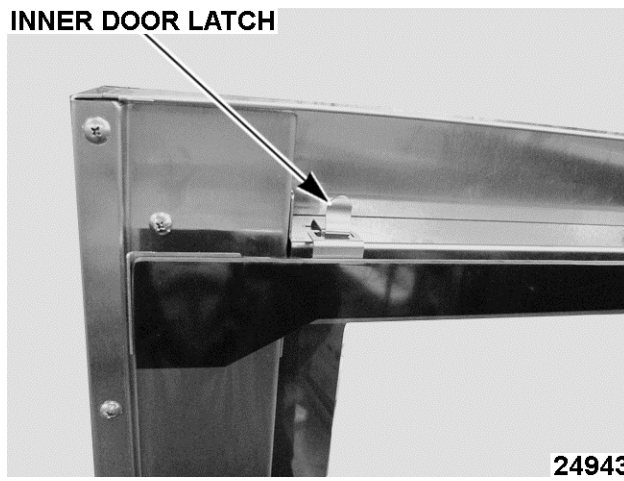

Fig. 25

3. Remove door lock cover.

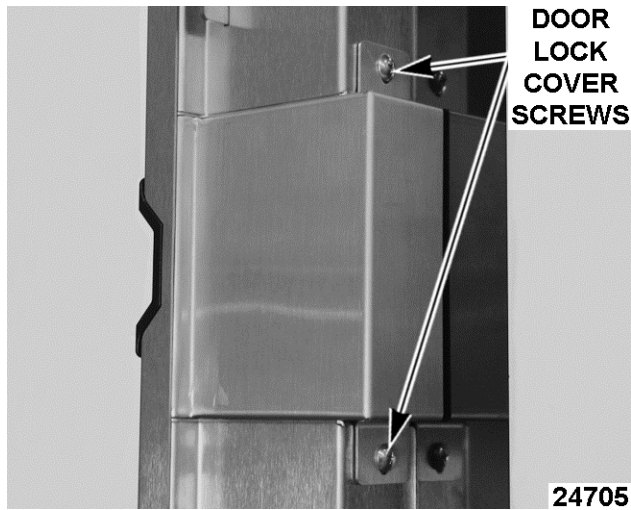

Fig. 26

4. Remove cam screw and washer.
5. Press torsion spring ends together to unlatch from door lock clamp bracket.

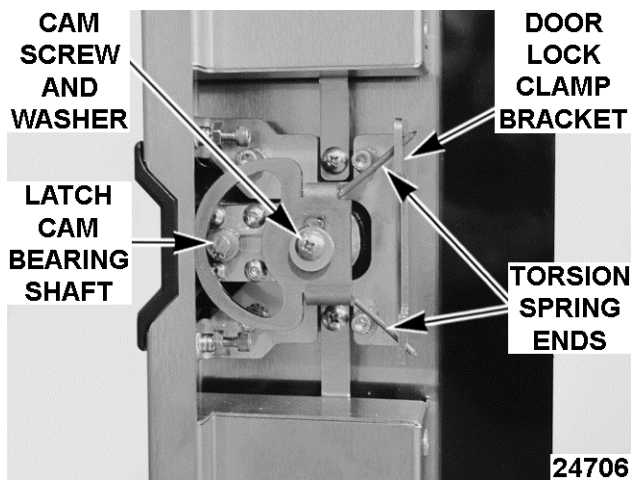

Fig. 27

6. Rotate door handle so that it faces up.

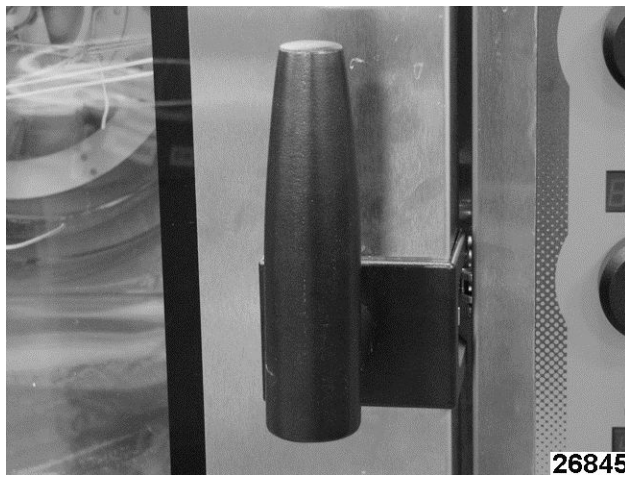

Fig. 28

7. Reassemble in reverse order.
8. Check for proper operation.