

# STANDCF60-BK/DW 60" HIGH SPEED CRANK ADJUSTABLE STAND UP DESK

## Product Specifications

Item Number	STANDCF60-BK/DW
Desktop Color	Dark Walnut
Frame Color	Black
Table Material	Melamine with PDF/PVC edge film
Frame	Powder-Coated Steel
Crank Type/Mechanism	High Speed Crank
Crank Speed	~33 cranks from low to high
Full Dimensions w/Casters	59" W x 29.5" D x 32.6" - 48.5" H
Full Dimensions w/Glides	59" W x 29.5" D x 29.6" - 45.4" H
Table Dimensions	59" W x 29.5" D x 0.625" H
Speed	1.2" per second
Anti-collision Technology	Yes
Stage of Each Leg	3 Stage
Actual Weight	90 lbs.
Weight Capacity	154 lbs.
Lift Capacity	154 lbs.
Glides	Furniture Glides
Casters	3" Casters
Ship Method	UPS Box 1 = 48"W x 12"D x 5"H Box 2 = 64"W x 35"D x 3"H
Shipping Weight	Box 1 = 61 lbs. Box 2 = 41 lbs.
Meets ANSI/BIFMA Standards	Yes
Assembly Required	Yes

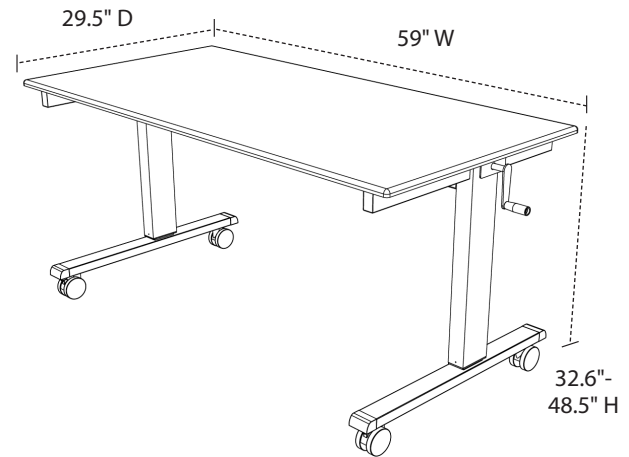

To Order, Call Your  
Sales Representative  
or 800-323-4656